

**MATERIAL SPECIFICATIONS:**

Body & Housing: PA, UL-94V-HB / UL-94V-0 rated, color black  
 Contacts: Brass, Gold plated

**MECHANICAL SPECIFICATIONS:**

Contacts: 8  
 Durability: >5000 mating cycles.  
 Cable Diameter: 2.5 - 8mm  
 Wire gauge: 24AWG max.

**ELECTRICAL SPECIFICATIONS:**

Rated current: 2A per contact  
 Rated voltage: 175V  
 Contact resistance: <15 mohms  
 Rated impulse voltage: 1750V

**IEC/UL 61010-1 SPECIFICATIONS:**

Material group: I, II  
 Overload category: II  
 Pollution degree: 2

**ENVIRONMENTAL SPECIFICATIONS:**

Degree of Protection: IP67 when mated  
 Operating Temperature: -25°C ~ +85°C

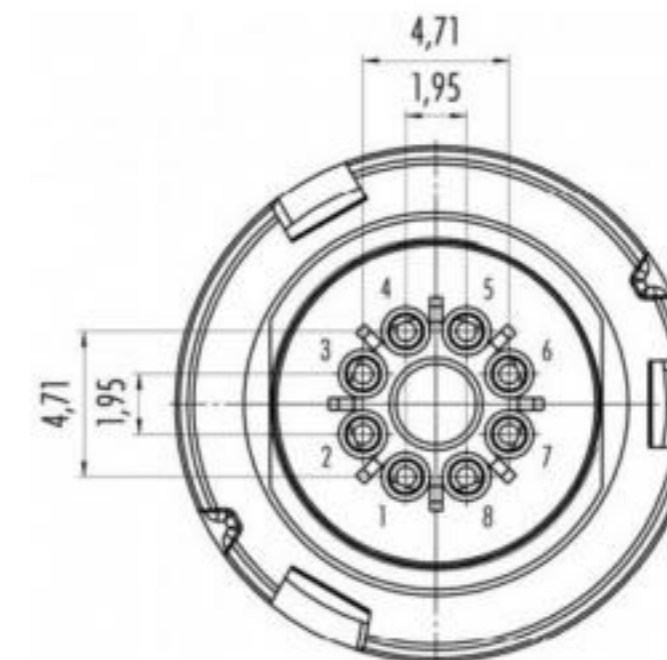

	X	Y
1	-0,98	-2,36
2	-2,36	-0,98
3	-2,36	0,98
4	-0,98	2,36
5	0,98	2,36
6	2,36	0,98
7	2,36	-0,98
8	0,98	-2,36

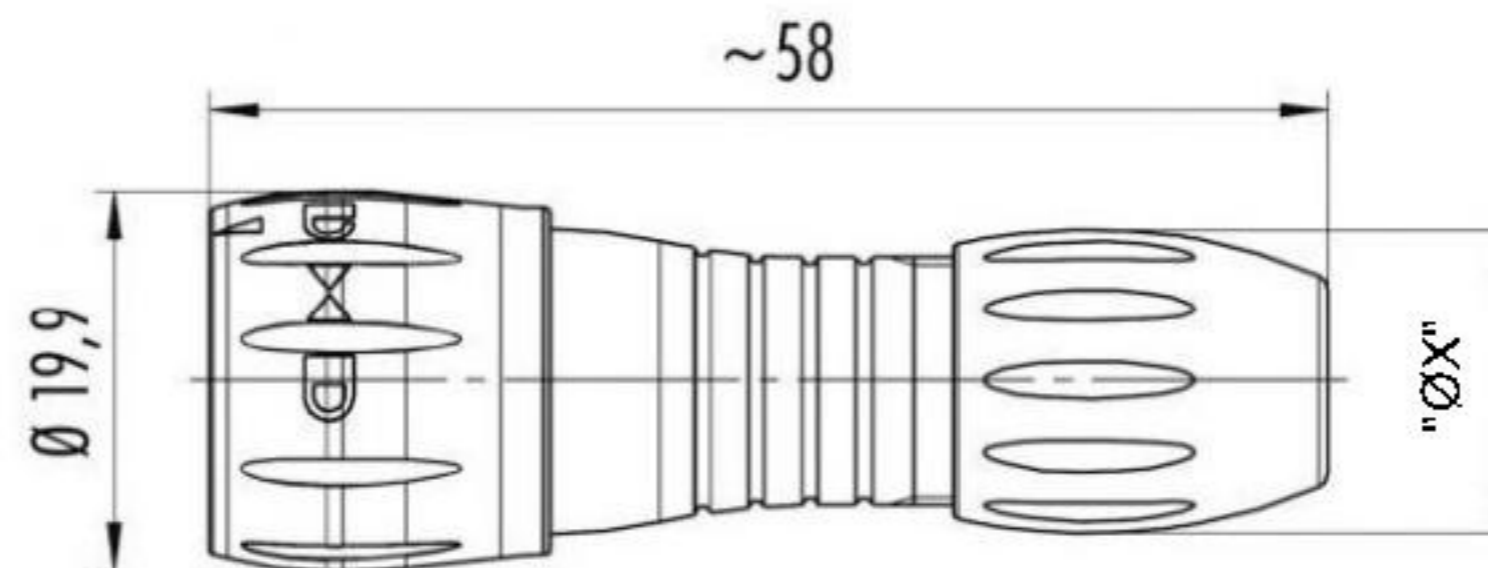

RoHS  
COMPLIANT

REVISIONS	CHNG	CHK	APPR
	CHANGE		
	DATE		
REV			

P/N	CABLE DIAMETER	Ø X
PD-HEC2-MCC-4	2.5 ~ 4mm	16mm
PD-HEC2-MCC-6	4 ~ 6mm	16mm
PD-HEC2-MCC-8	6 ~ 8mm	19mm

TOLERANCE UNLESS OTHERWISE SPECIFIED	
X	± 1
X.X	± 0.4
X.XX	± 0.13
DRAWN BY	PB
DATE:	10/27/14
CHECK BY	
DATE:	
APPR BY	
DATE:	

**Power Dynamics, Inc.**  
 Phone: 973 560-0019 Whippany, New Jersey Fax: 973 560-0076

PART: HARSH ENVIRONMENT CONNECTOR  
 SERIES 2 MALE CABLE CONNECTOR

**PD-HEC2-MCC-X**

PART #

SIZE: A

SCALE: NTS

ALL DIMENSIONS FOR REFERENCE ONLY  
 DIMENSIONS ARE IN MILLIMETERS

SHEET 1 of 1

REV: